

TCL

S55H

2.1 Channel Dolby Atmos Sound Bar with Wireless Subwoofer

Quick Start Guide



1

Register Your Product

Register your TCL Sound Bar to receive the latest news on product releases, promotional offers, and more!*

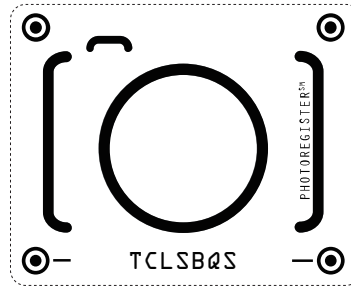

TEXT TO REGISTER

Text a photo of the camera icon to 71403

Or register online at register.tcl.com

Need help? Visit photoregister.com/help or text HELP to 71403

Enjoy exclusive benefits with registration:



Expedited support and service



Insider tips on your Sound Bar



Exclusive offers and promotions



Verification of ownership

*Only Available to U.S. Customers

2

What's in the box

Make sure you read all the safety information before you use this product.

User Manual can be found at www.tcl.com/us on the specific product page in the "Download" section.



Warning:

To avoid the danger of suffocation, keep plastic packaging away from pets, babies, and children. Do not use packaging bags in cribs, beds, carriages, or playpens.

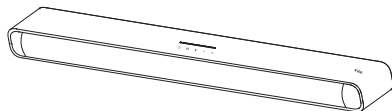

Sound Bar



Subwoofer



Power cord x 2
(Cable length: 4 ft. 11")



HDMI cable
(Cable length: 4 ft. 11")



Remote control



AAA battery x 2



Wall mount bracket x 2



Wall anchor x 2



Wall mounting screw x 2

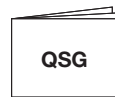

Quick Start Guide

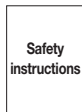

Safety leaflet

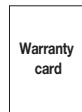

Warranty card

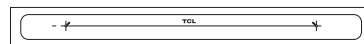

Wall mount template

Sound Bar

- ❶ AC input power connector
- ❷ AUX input connector
- ❸ HDMI eARC connector
- ❹ Optical input connector
- ❺ USB Type A connector

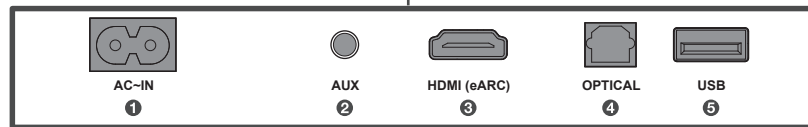
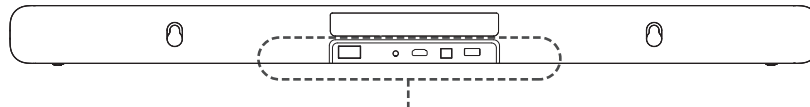

Source button:

Short Press: Switch input sources
(HDMI eARC/Optical/AUX/USB/Bluetooth)
Long Press: Enter Subwoofer pairing
(If Subwoofer disconnected)

Volume buttons:

Press to increase or
decrease the volume level



Power button:

Short Press: Power on/sleep
Long Press: Power off

Bluetooth button:

Short Press: Select Bluetooth mode
Long Press: Bluetooth pairing

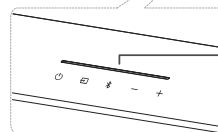
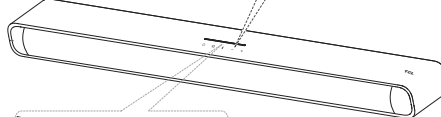

Input Source LED Indicator:

HDMI eARC: Magenta

Optical: Yellow

AUX: Green

USB: Cyan



Bluetooth: Blue

3b

Overview

Wireless subwoofer

THE SUBWOOFER WILL PAIR AUTOMATICALLY WITH SOUND BAR UPON THE FIRST USE. In case of a problem, take the following steps to manually pair:

1. Press and hold the  button on the Subwoofer for 3 seconds until an amber light begins flashing above the pair button.
2. Press and hold the  button on the Sound Bar for 10 seconds until a yellow LED indicator flashes on the Sound Bar. After a short while, a green LED indicator will be on for 5 seconds.
3. The Subwoofer is now connected to the Sound Bar.

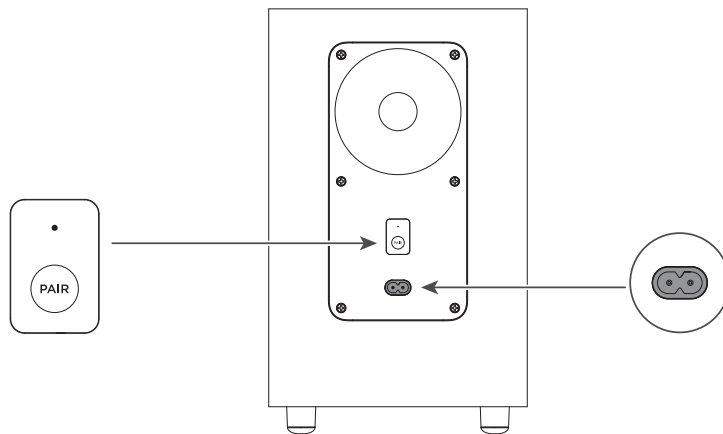

4

Sound Bar LED Display

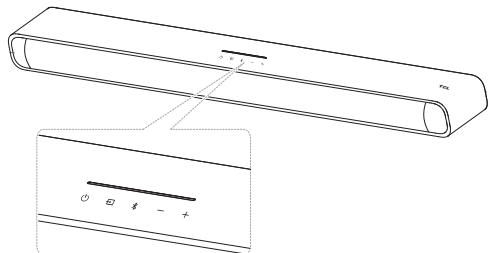

The LED display on the Sound Bar gives you information about the LED Behavior on Sound Bar.

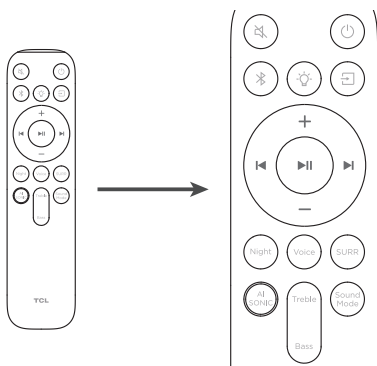

Remote Control	Sound Bar Action	LED Behavior on Sound Bar
	Power Off/Sleep Power On	Power Off: All LEDs light turn on and turn off from the sides to the center. Power On: LEDs will turn on from the center to the sides.
	Mute Sound	Mute On: Center LED will flash several times. Mute Off: Current Volume Level will be shown.
	Source	Input Source LED Indicator: HDMI eARC: Magenta Optical: Yellow Aux: Green USB: Cyan Bluetooth: Blue
	LED	Short Press: Change different LED brightness levels. Long Press: Switch between LED light on or turn off.
	Bluetooth Pairing	Blue LED will flash rapidly.
	Volume Up/Down	Volume Up: LEDs will gradually turn on from the center to the sides. Volume Down: LEDs will gradually turn off from the sides to the center.
	Skip/Previous Play/Pause	Skip: LEDs move from the left to the right. Previous: LEDs move from the right to the left. Play/Pause: Short press to play or pause playing under Bluetooth or USB mode.
	Surround Enhance	Press to adjust four different surround sound levels.
	Voice Enhance	Short Press: Show the current Voice Enhance level. Use +/- keys to adjust four different levels.
	Night Mode	Night Mode on: LEDs will turn on from the center to the sides. Night Mode off: All LEDs light turn on and turn off from the sides to the center.
	Sound Mode	Press to switch sound mode in following order: Standard /Movie/Music/Voice/Game/Sports
	Treble Adjustment	Short Press: Show the current Treble level. Increase/Decrease using +/- keys to adjust thirteen different levels.
	Bass Adjustment	Short Press: Show the current Bass level. Increase/Decrease using +/- keys to adjust thirteen different levels.
	Sonic Default/1/2/3	Short Press to enter AI Sonic-Adaptation Menu Short press +/- to switch different AI Sonic-Adaptation: Default/Sonic 1/Sonic 2/Sonic 3

5a

Place your Sound Bar and Subwoofer

The ideal place to position the Sound Bar is centered underneath your TV.

The ideal place to position the subwoofer is adjacent to the TV on the floor.



Note: Do not place your Sound Bar in a location exposed to direct sunlight, heat, fire, or moisture.

Top View

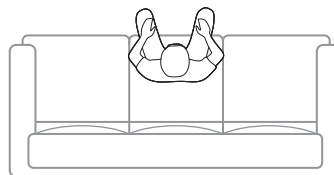
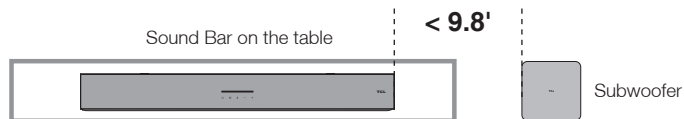

5b

Wall mount your Sound Bar

Required tools:

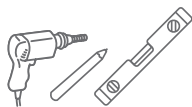

- 1 Place the supplied wall mount template on the wall. Make sure the wall mount template is at least 2 inches below the center of the TV.
- 2 Use a level to make sure the wall mount template is positioned accurately
- 3 Use the tape to stick the wall mount template firmly on the wall.
- 4 Mark on the wall using each marking on the template through the mounting holes.
- 5 Take away the wall mount template.
- 6 Drill a screw hole at each marking on the wall.

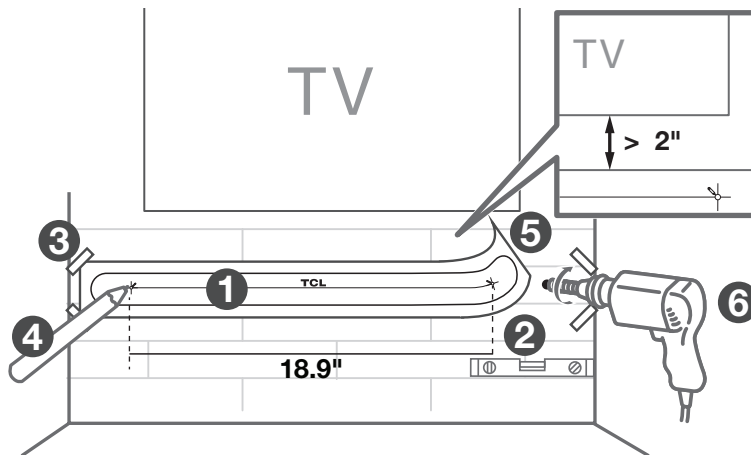

5c

Wall mount your Sound Bar

Required tools:



- 7 Insert the wall anchors in the holes on the wall.
- 8 Insert the supplied screws with the wall brackets into the hole of the wall anchors.
- 9 Fix and tighten the wall bracket screws on the wall. (Keep space between the screw cap and the brackets)
- 10 Pick up the Sound Bar and attach it to the wall screws, similar to how you would hang a picture. Make sure everything is tight.



Note:

Do not place your Sound Bar in a location exposed to direct sunlight, heat, fire, or moisture. Only suitable for mounting at heights: < 6 ft. 6.7 in.

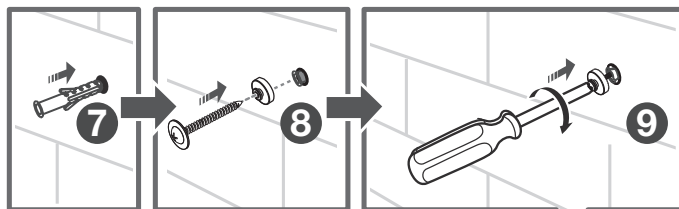

10

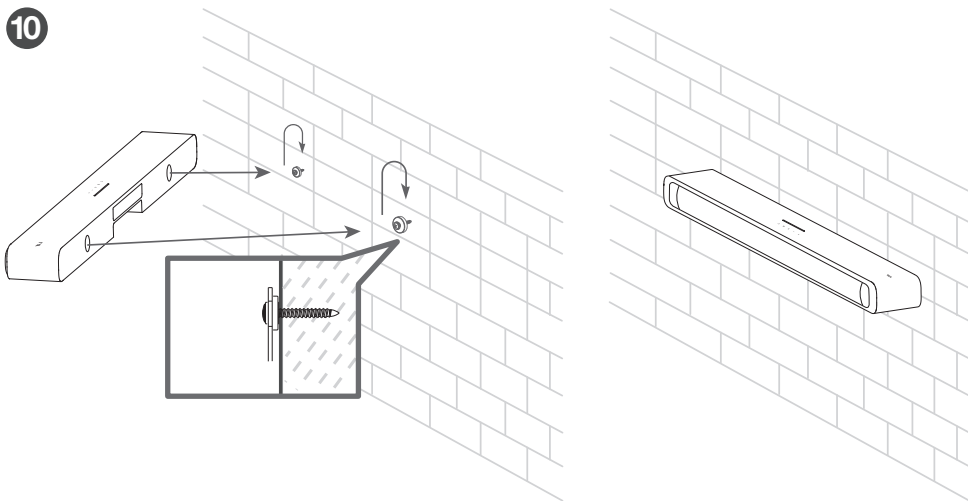

6a

Install or replace the remote batteries

Battery type: 1.5V AAA battery x 2

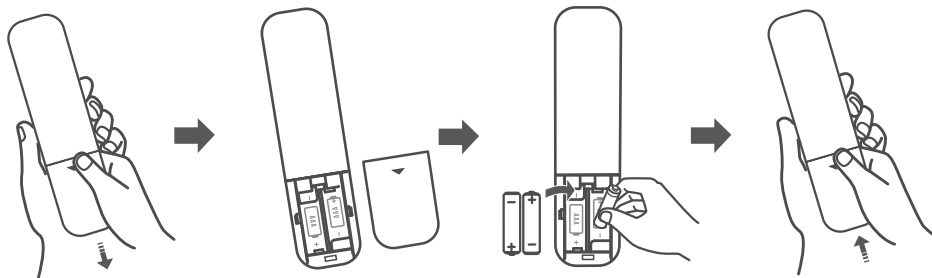

6b

Use the Remote

Battery CAUTION & Disposal Information:

- For best results, use alkaline-type batteries.
- Do not mix Alkaline, Standard (Carbon-Zinc), or Rechargeable (Nickel Cadmium or Nickel Metal Hydride) batteries.
- Always replace depleted batteries with two same brand-new batteries from the same manufacturer. Never use damaged batteries.
- Do not use Rechargeable (Nickel Cadmium or Nickel Metal Hydride) batteries.
- Install only new batteries of the same type in your product. There is a risk of fire or explosion if the battery is replaced by an incorrect type.
- Do not mix old and new batteries.
- Batteries should not be exposed to excessive heat, such as prolonged direct sunlight, open flame, or fire of any kind as it may result in an explosion, or leakage of flammable liquid, or gas.
- Batteries should not be exposed to extremely low air pressure as it may result in an explosion or the leakage of flammable liquid or gas.
- Failure to insert batteries in the correct polarity, as indicated in the battery compartment, may shorten the life of the batteries or cause batteries to leak.
- Batteries should be recycled or disposed of as per state and local guidelines. Do not dispose of batteries in a fire, hot oven, or mechanically crushing or cutting a battery, which may result in an explosion.

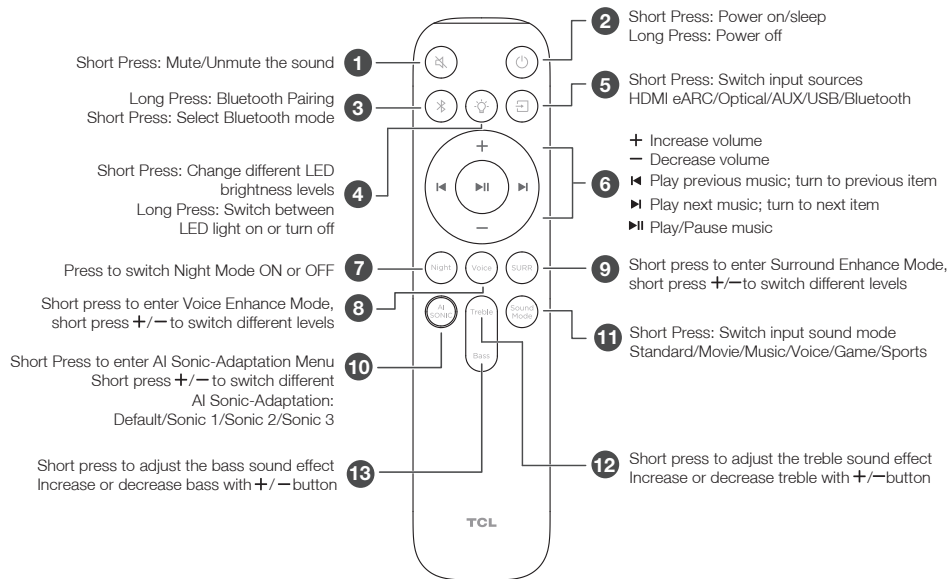

Combination keys:

- Press both and simultaneously to activate or deactivate DTS TruVolume.
- Press both and simultaneously to activate or deactivate DTS® Virtual:X™.

7

Connect to your TV

There are 2 ways to connect your Sound Bar to the TV (listed in order that we recommend):
HDMI eARC (refer to 7a),
and Optical (refer to 7b).

If you have a TCL/Roku TV™, simply plug in the HDMI cable to the eARC/ARC ports and follow the Roku TV Ready™ on-screen instructions.



This function is available in some TCL TVs and some TCL models.



- ✓ Simple setup
- ✓ One remote
- ✓ Quick settings

7a

HDMI (eARC)

Connect the Sound Bar to your TV with the included HDMI cable.

Connect the Sound Bar to the power outlet with the included power cord.

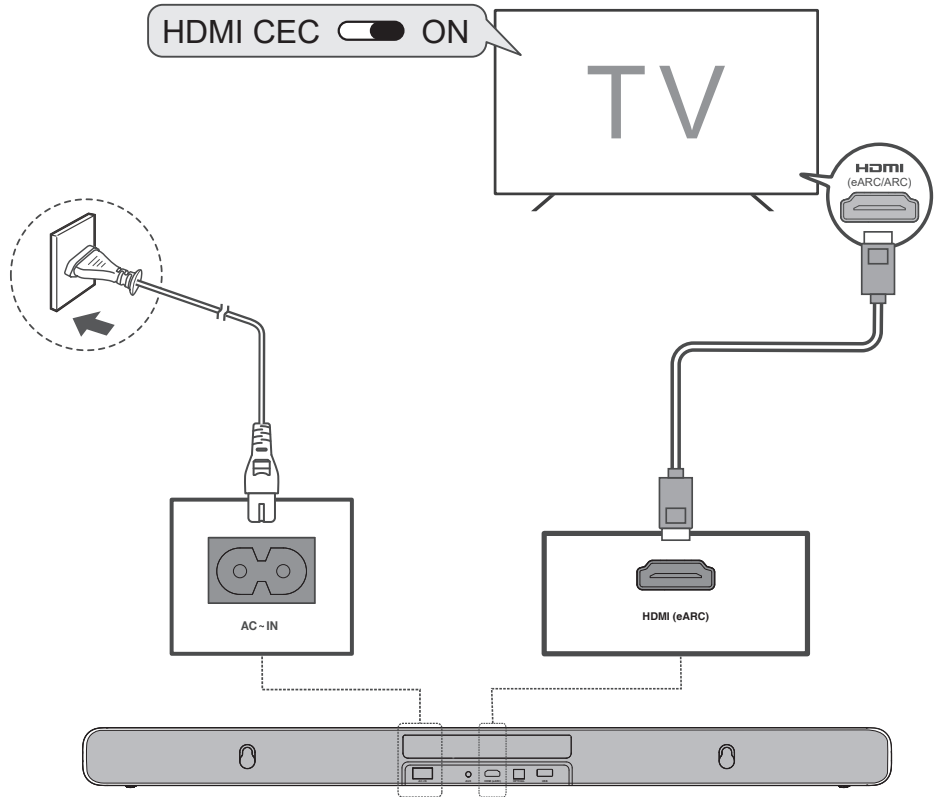

7a

HDMI (eARC)

Enable CEC function on TCL TV.

- 1 Connect HDMI cable from the HDMI (eARC) interface on the Sound Bar to the HDMI (eARC/ARC) interface on the TV.
- 2 Enable the CEC function in the settings of the TCL TV.
(See TV User Manual for instructions)

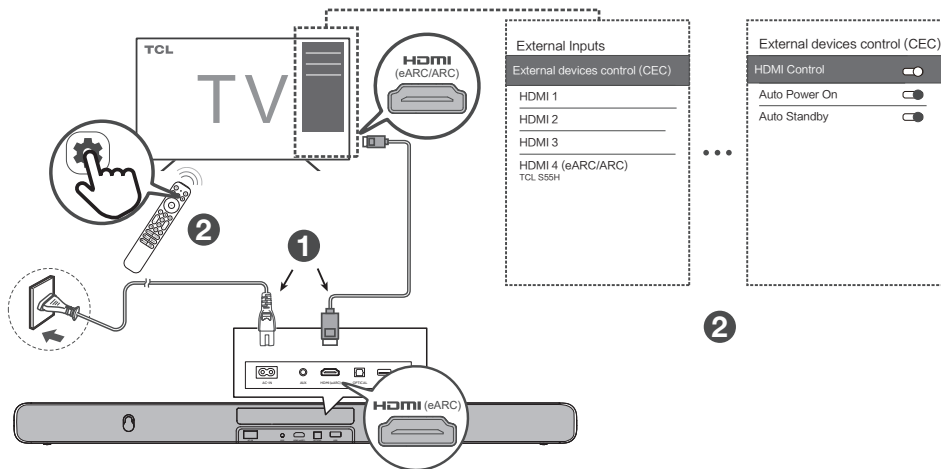

Enable CEC function on other brand TV.

- 1 Connect HDMI cable from the HDMI (eARC) interface on the Sound Bar to the HDMI (eARC/ARC) interface on the TV.
- 2 Enable the CEC function in the settings of the TV.



Note:
CEC (Consumer Electronic Control) function naming may differ by TV manufacturer. This feature may be called CEC, Anynet+, SimpLink, BRAVIA Link, EasyLink or VIERA Link. Please see your TV's user manual for more information.

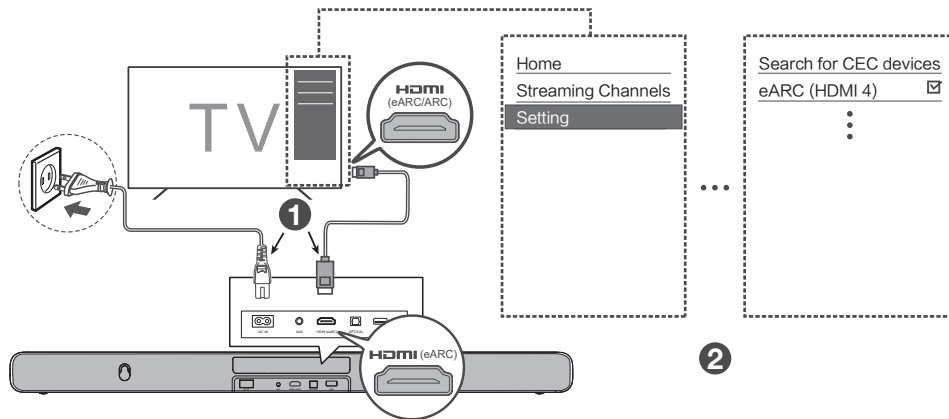

7b Optical

Connect the Sound Bar to the TV with an Optical cable.

Connect the Sound Bar to the power supply with the included power cord.



Warning:
Do not bend or kink the optical cable (SPDIF) as it is fragile and can easily get damaged and broken.

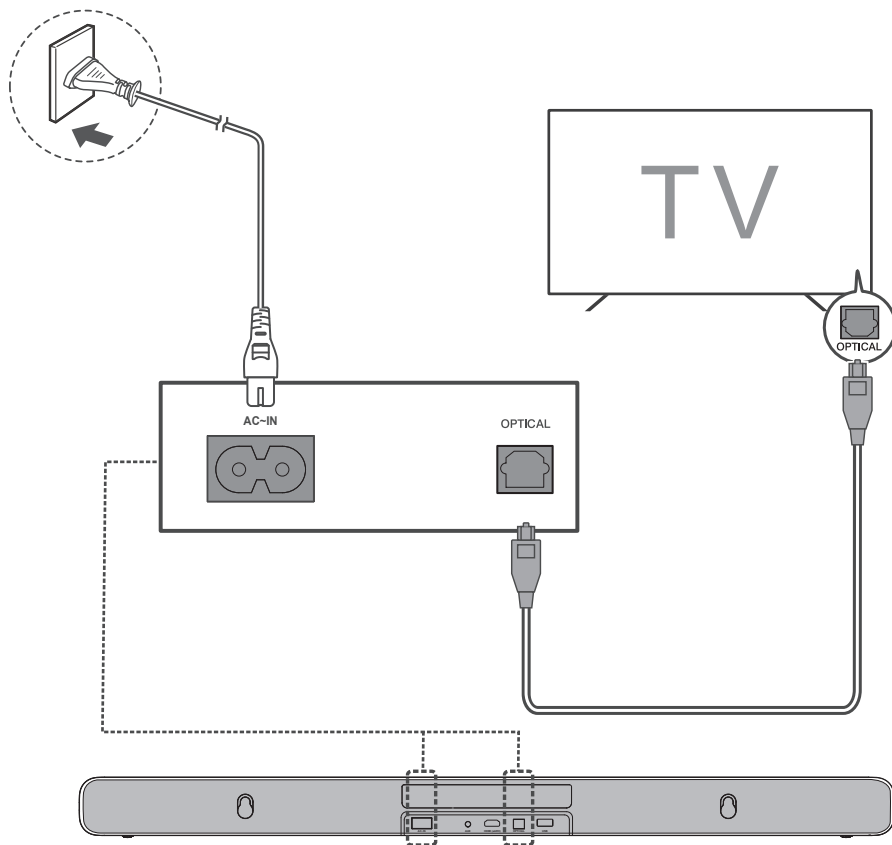

8

Pair with your Bluetooth device

You can stream music from your mobile device via Bluetooth.

- 1 Press .
- 2 Press .
- 3 Press and hold  on the Remote Control or press and hold  on your Sound Bar.
 - > You will see blue lights flash rapidly.
 - > The Sound Bar is ready to pair.
- 4 Power on your Bluetooth device and activate its Bluetooth function.
 - > You will see the blue light on for 3 seconds.
- 5 Select **TCL S55H**.
 - > Pairing is successful.
- 6 If you want to pair another device, please repeat step 3.

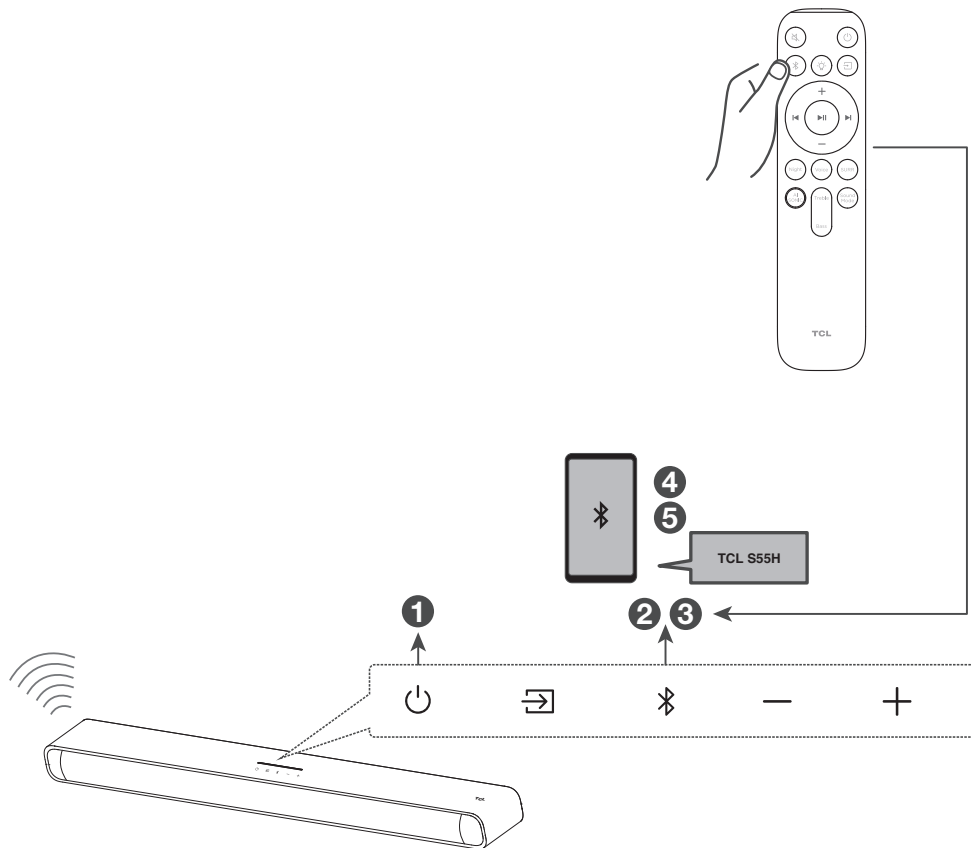

9a

Other connections - USB

Supported audio files: MP3, WMA, WAV, FLAC.

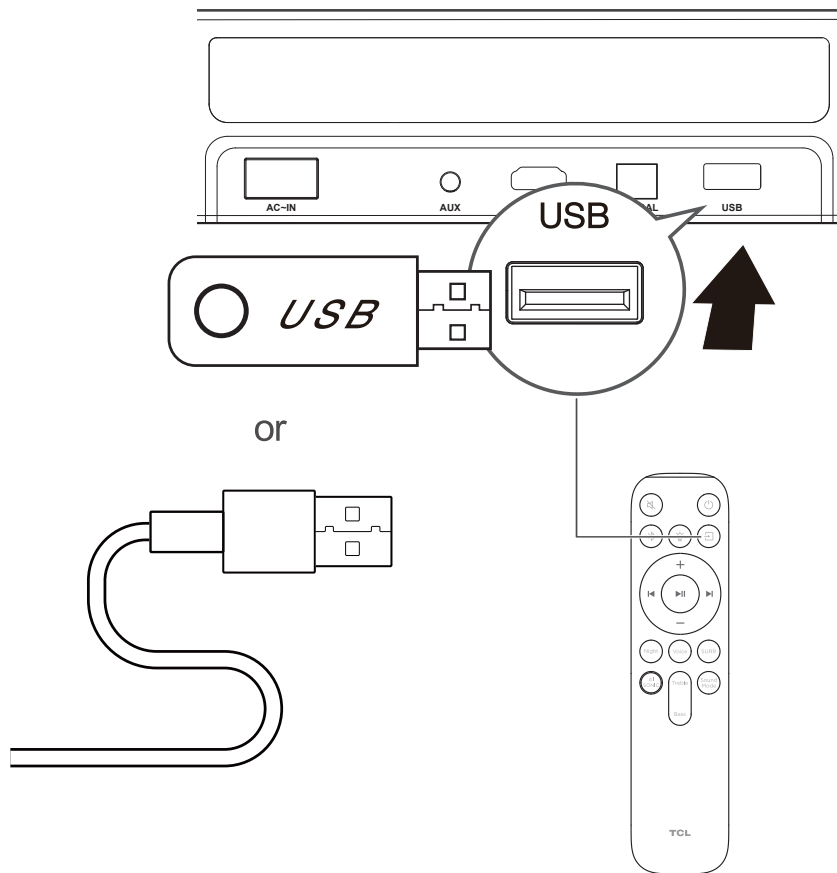

9b

Other connections - AUX



or



Cables are not included.

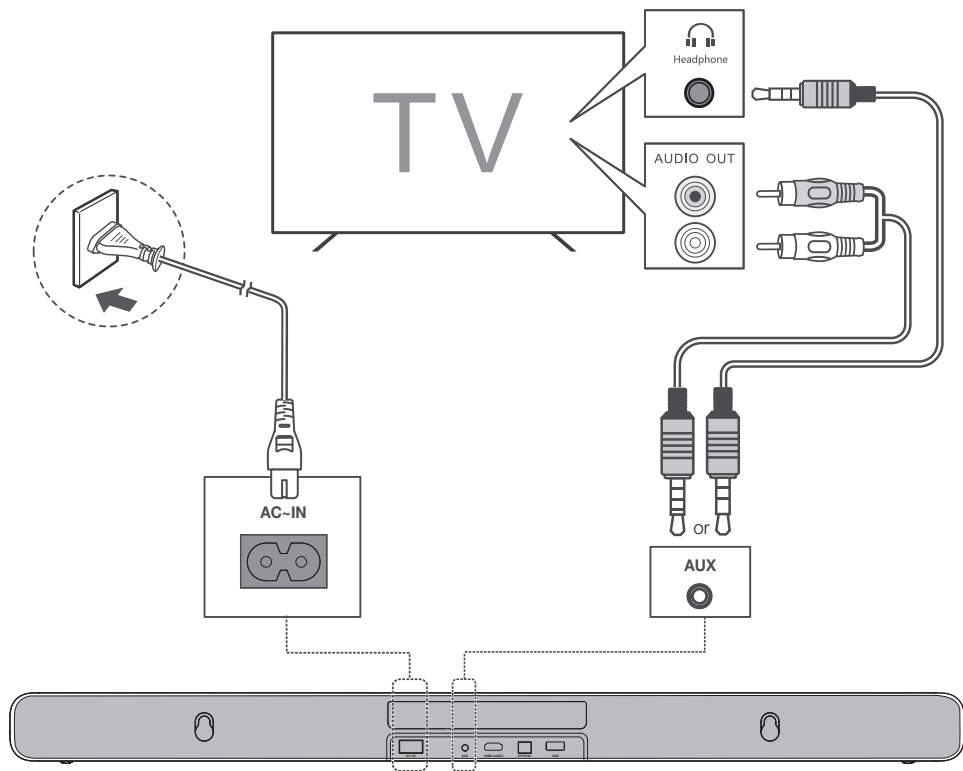

When the Sound Bar is connected, "TV+Sound Bar" menu appears on the TV.

Settings → Display & Sound → Audio Output → Internal Speaker+Sound Bar(HDMI)



Note:

The message displayed may differ with the TV model.

This function is compatible with some TCL TVs. The operation methods for different televisions may vary.

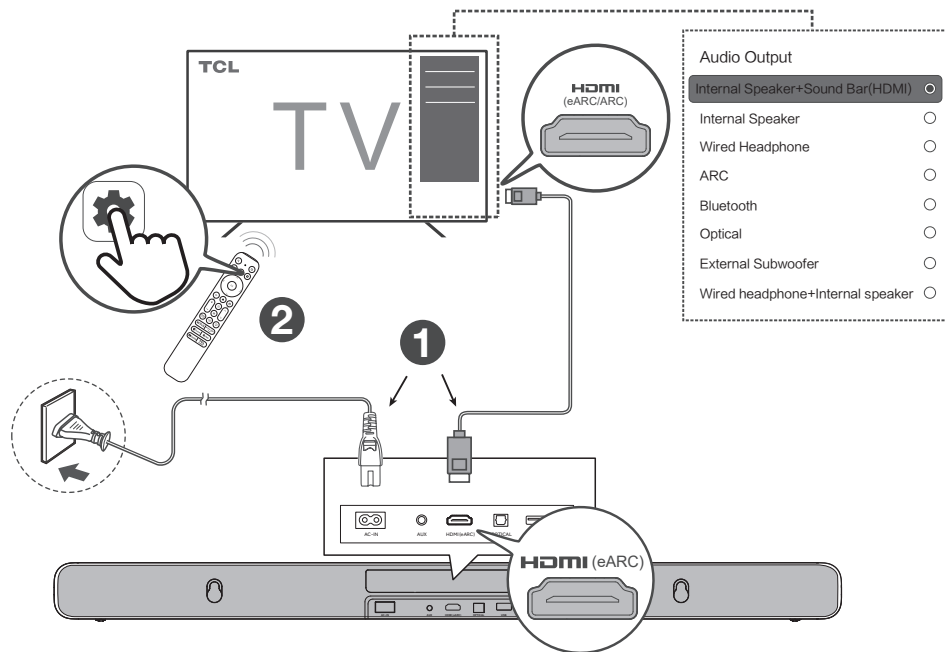

11

AI Sonic-Adaptation

AI Sonic-Adaptation is a Room Calibration Technology developed by TCL Audio Lab. To use this function, you need to download TCL Home App and follow the instructions.

Before AI Sonic-Adaptation

Speaker distance, sound pressure level, and frequency response are all uneven. Based on your sitting area and room field.

After AI Sonic-Adaptation

Speaker distance, sound pressure level, and frequency response are all equalized. Based on your sitting area and room field.

12

Download TCL-HOME App

This S-Series Sound Bar can be fully controlled via the TCL Home App, including power, volume, input switching, effects, AI Sonic-Adaptation and more. Use the TCL Home App to explore additional smart features.

Please download the latest version from the app stores.



TCL Home App
Your TCL Smart Hub.
Download Now!

What is AI Sonic-Adaptation?

How It Works?

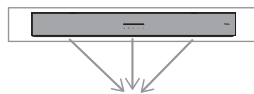

The sound field will be measured by cellphone and microphone.



Follow the on-screen instructions in the TCL Home App.

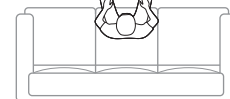
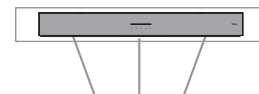
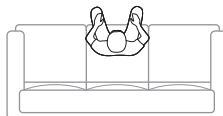

13

Online Firmware Update

Follow the instructions on the right side to update the firmware on TCL-HOME app.



Note:
The message displayed may differ.
Do not exit the TCL-HOME app during the update process.

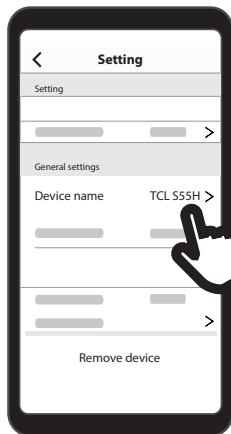

1

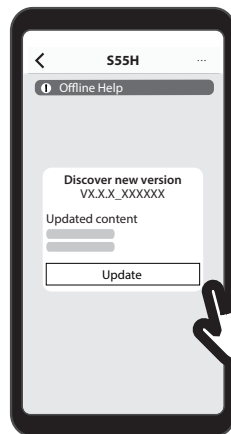

2

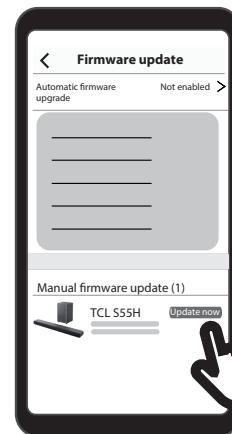

3

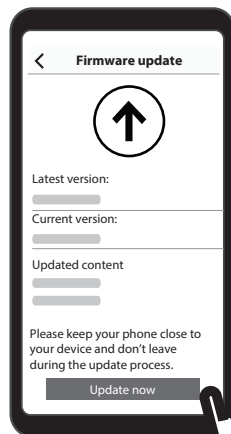

4

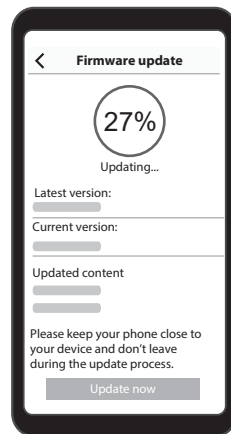

5

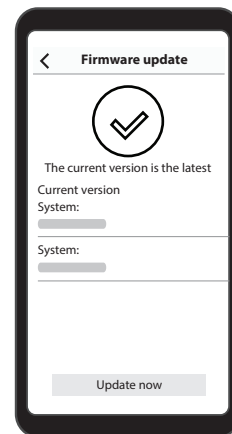

Trademarks



Roku, the Roku logo, Roku TV, Roku TV Ready, and the Roku TV Ready logo are trademarks and/or registered trademarks of Roku, Inc. This product is Roku TV Ready-supported in the United States and Canada. Countries are subject to change. For the most current list of countries in which this product is Roku TV Ready-supported, please email rokutvready@roku.com.



Dolby, Dolby Atmos, and the double-D symbol are registered trademarks of Dolby Laboratories Licensing Corporation. Manufactured under license from Dolby Laboratories. Confidential unpublished works. Copyright © 2012-2024 Dolby Laboratories. All rights reserved.



The Bluetooth® word mark and logos are registered trademarks owned by Bluetooth SIG, Inc. and any use of such marks by TTE Corporation is under license. Other trademarks and trade names are those of their respective owners.



For DTS patents, see <http://patents.dts.com>. Manufactured under license from DTS, Inc. DTS, Digital Surround, Virtual:X, and the DTS logo are registered trademarks or trademarks of DTS, Inc. in the United States and other countries.

© 2024 DTS, Inc. ALL RIGHTS RESERVED



“The terms HDMI, HDMI High-Definition Multimedia Interface, HDMI trade dress and the HDMI Logos are trademarks or registered trademarks of HDMI Licensing Administrator, Inc.”

DO NOT RETURN TO STORE

**WE ARE
READY TO
HELP** contact us first
with any questions



TCL SUPPORT:
support.tcl.com
1-877-300-9223



**TAKE CARE WHEN
REMOVING THE SOUND BAR**